

# PRODUCT DATA

COMFORT 450 BY NILAN



## Ventilation & passive heat recovery



Domestic



Passive  
heat recovery



Ventilation  
< 450 m<sup>3</sup>/h

# COMFORT 450

## Product description

The Comfort 450 is an energy-efficient ventilation unit with heat recovery for homes and smaller commercial buildings with a ventilation requirement of up to 450 m<sup>3</sup>/h.

This unit has been thoroughly tested, with improvements being continually made during its manufacture for more than 15 years. These have focused on low energy consumption, easy user operation and maintenance.

The Comfort 450 is a compact unit which can be ordered as a left- or right-handed model.

The Comfort 450 is factory tested and ready for use. Installation and commissioning must be performed by an authorised electrician.

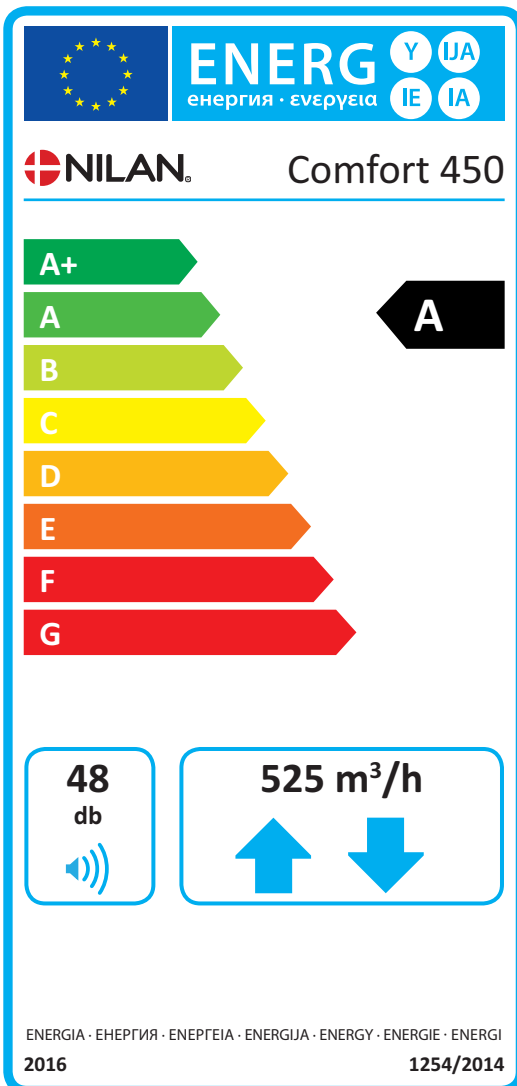

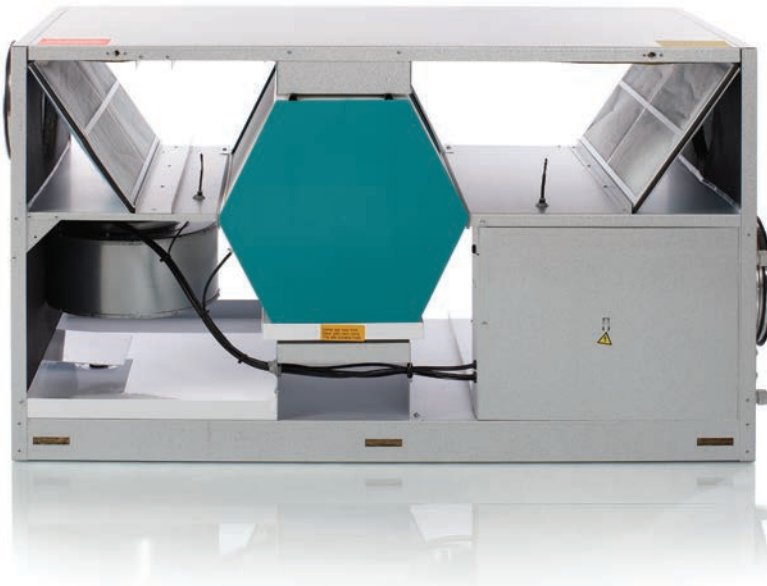

The large door provides easy access for changing filters and cleaning the unit.



Counterflow heat exchanger made of polystyrene, which has a higher temperature efficiency than aluminium exchangers.



Intelligent humidity sensors provide an option for controlling the ventilation as required, based on the average air humidity in the home.

A CO<sub>2</sub> sensor can be purchased as an accessory.



The unit comes with a clear and user-friendly operating panel.

The modern CTS 602 control panel runs Modbus communication.



The powder-coated condensate drain prevents the formation of "acid water" and allows the condensate to be drained away.



The efficient fans are powered by energy-saving EC motors.

They provide a constant air volume with a four-step adjustment.

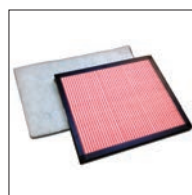

Filter monitor with timer

G4 filters are supplied as standard, but it is also possible to buy a F7 pollen filter as an accessory.



Prepared for an integrated or external water heating element.



The automatic bypass damper makes the outdoor air bypass the heat exchanger when heat recovery is not required, thereby saving energy.

Bypass cooling as an option.

# TECHNICAL DATA

## Technical specifications

Dimensions (W x D x H)	1100 x 650 x 640 mm
Weight (1*)	72/51.5 kg
Plate type casing	Aluzinc steel plate
Heat exchanger type	Polystyrene counterflow heat exchanger
Fan type	EC, constant volume
Filter class	Standard G4
Duct connections	Ø 200 mm
Condensate drain	PVC, Ø 20x1,5 mm
Leakage classification (2*)	A1

Supply voltage	230 V (±10 %), 50/60 HZ
Max. input/power	370 W/2.9 A
Tightness class	IP31
Standby power	3 W
Ambient temperature	-20/+40 °C
Heat loss (3*)	0,82 W/m²K
Heat loss classification	T2

\*1 33 kg is without side plates and exchanger

\*2 Testet according to EN13141-7

\*3 Testet according to EN1886

## Data ecodesign

SEC* average climate	-39,8 kWh/(m².a)
SEC* cold climate	-77,7 kWh/(m².a)
SEC* warm climate	-15,5 kWh/(m².a)
SEC-Class	A
Type	Residential ventilation unit
Type of drive	Variable speed drive
Type of heat recovery system	Recuperative (counterflow heat exchanger)
Thermal efficiency of heat recovery	86 %
Maximum flow rate	525 m³/h (100 Pa)
Electric power input of fan drive, including any motor control equipment, at maximum flow rate	190 W
Sound power level L <sub>WA</sub>	48 dB(A)
Reference flow rate	0,102 m³/s (367 m³/h)
Reference pressure difference	50 Pa
SPI	0,22 W/(m³/h)
Central demand control	0,85
Maximum internal leakage	1,9 %
Maximum external leakage	0,7 %
Visual filter warning	A yellow light flashes on the user panel when filters need changing. To maintain the performance and energy efficiency of the unit it is very important to change filters regularly.
Disassembly instructions	www.nilan.dk

AEC - annual electricity consumption	5,0 kWh/år
AHS** average climate	45,2 kWh
AHS** cold climate	88,5 kWh
AHS** warm climate	20,4 kWh

\*\* Annual heating saved

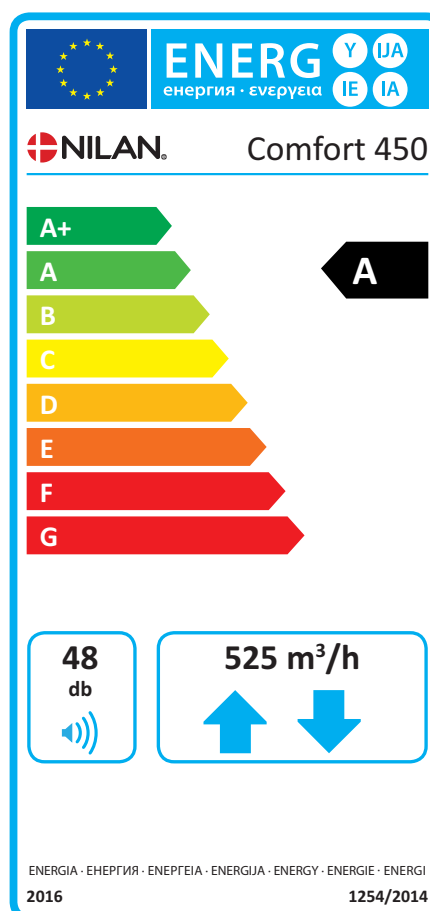

\* Specific energy consumption

## Dimensional drawing

All dimensions are in mm.

Left model

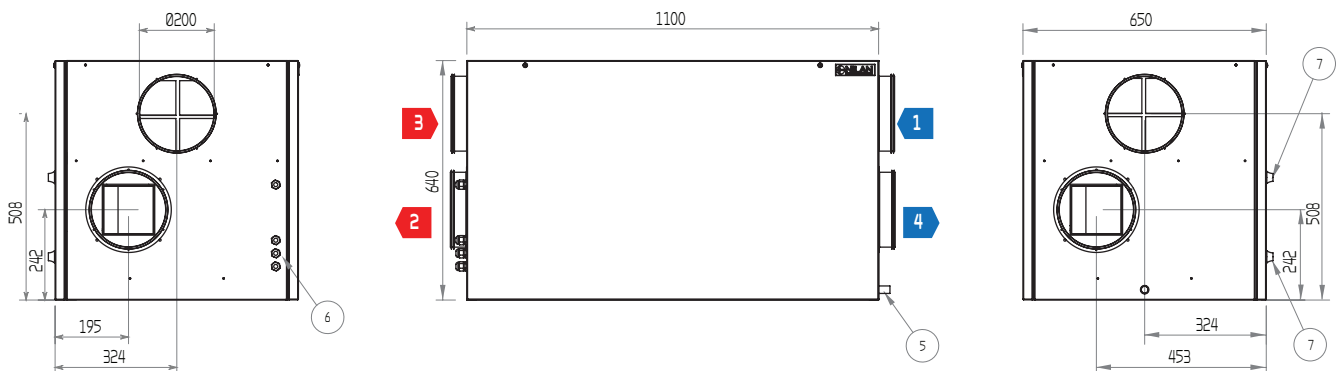

Right model

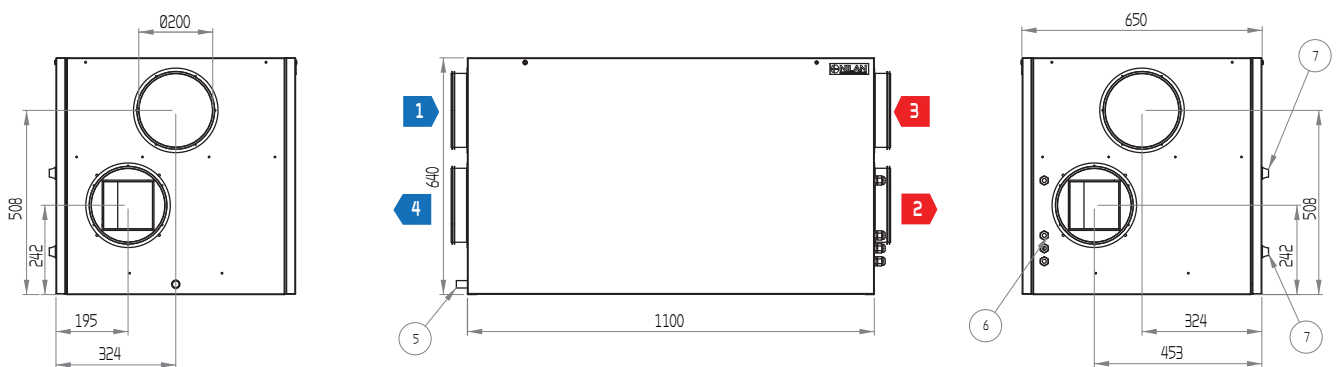

### Connections

- |                  |                                  |
|------------------|----------------------------------|
| 1: Fresh air     | 5: Condensate drain              |
| 2: Supply air    | 6: Electric and water heating    |
| 3: Extract air   | 7: Primary side (heat exchanger) |
| 4: Discharge air |                                  |

# PLANNING DATA

Nilan units are tested in accordance with the valid standards of accredited independent test institutes.

## Capacity

Capacity of standard unit as a function of  $q_v$  and  $P_{t,ext}$ .

SFP values according to EN 13141-7 are for standard units with G4 filters and without heating element.

SFP values comprise the unit's total power consumption incl. control.

Conversion factor:  $\frac{J/m^3}{3600} = W/m^3/h$

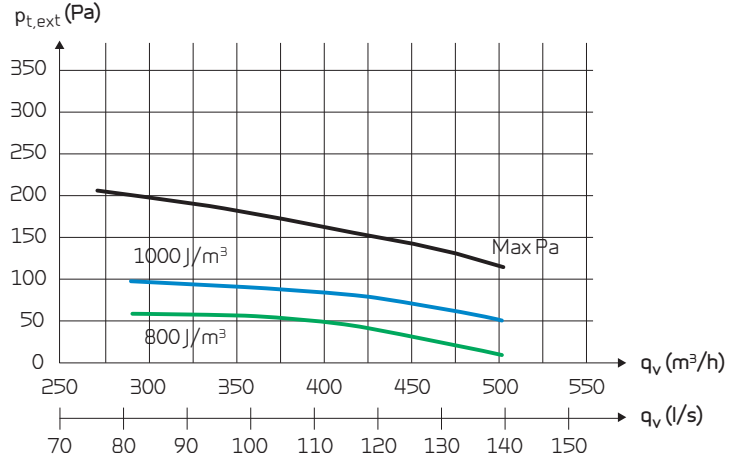

## Temperature efficiency

Temperature efficiency for units with counterflow heat exchanger according to EN308 (dry).

Temperature efficiency EN308:

$$\eta_t = (t_{\text{supply air}} - t_{\text{fresh air}}) / (t_{\text{extract air}} - t_{\text{fresh air}})$$

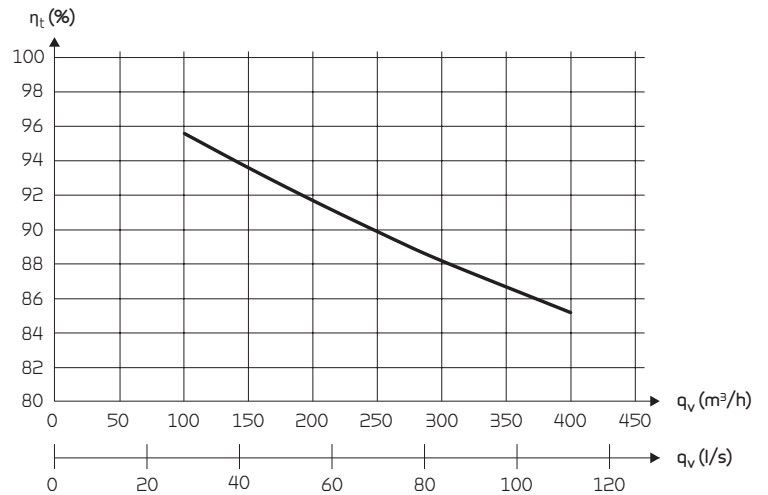

## Sound data

Sound data for  $q_v = 300 \text{ m}^3/\text{h}$  and  $P_{t,ext} = 100 \text{ Pa}$  according to EN 9614-2 for surfaces and EN 5136 for ducts.

Sound output level  $L_{WA}$  drops with falling air volume and falling back pressure.

Sound output level  $L_{pA}$  at a given distance will depend on acoustic conditions in the place of installation.

### Sound output level ( $L_{WA}$ )

Octave band Hz	Surface dB(A)	Supply air dB(A)	Extract air dB(A)
63	29	56	38
125	40	56	40
250	41	57	37
500	46	61	32
1000	40	59	22
2000	29	58	22
4000	17	55	17
8000	14	54	15
Total $\pm 2 \text{ dB(A)}$	48	66	44

## Capacity - Heating element (accessory)

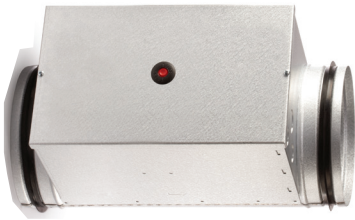

### Electrical heating surface

The electrical heating surface is fitted in the air inlet duct at a distance of min. 2 x duct diameter from the system's fresh air inlet connection pipe (normally min 320 mm.) and connected to the CTS 602 control panel and power supply.

Electric heating element can be ordered for the Comfort 450, with an output of 3.0 kW (230V).

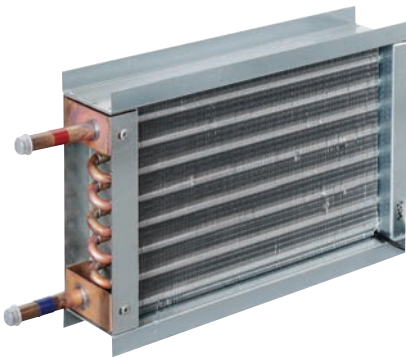

### Water heating element for internal fitting

The water heating element is designed to be built into the system and must be connected to the primary heating supply and the CTS 602 control. The water heating element includes copper pipes and aluminium fins.

Capacities can be seen in the table below.

### Capacity water heating element

Temperature input/output [°C]	Water side			Air side			
	Flow [m³/h]	Pressure drop [kPa]	Output [kW]	Flow [m³/h]	Temperature before WHE* [°C]	Temperature after WHE* [°C]	Pressure drop over WHE* [Pa]
40/30	0.05	1.6	0.61	100	16	34	2
	0.1	5	1.13	220	16	31.1	3
	0.14	8.7	1.6	350	16	29.3	5
	0.18	13.5	2.03	500	16	27.9	9
60/40	0.05	1.3	1.11	100	16	48.6	2
	0.09	3.8	2.05	220	16	43.3	3
	0.13	6.9	2.87	350	16	40	5
	0.16	10.7	3.66	500	16	37.5	9
70/40	0.04	0.8	1.28	100	16	53.6	2
	0.07	2.3	2.34	220	16	47.1	3
	0.09	4.1	3.24	350	16	43.1	5
	0.12	6.3	4.12	500	16	40.1	9

\* Water heating element.

# AUTOMATION

## CTS602 Control



The Comfort 450 is controlled using its CTS 602 operating panel, featuring a wide range of functions, e.g., menu-controlled operation, weekly programme settings, filter monitor with timer, fan speed adjustment, summer bypass (free cooling), post-heating element control, error messages etc.

The CTS 602 comes with factory settings, including a default setting which can be customised to operational requirements to achieve optimum operation and utilisation of the system.

The operating panel must be placed in a dry, frost-free location, at least 1.5 m above floor level and at least 0.5 m from any corner. Avoid placing the panel on an external wall or in areas in direct sunlight.

Operating instructions for the CTS 602 can be found in a separate user manual supplied with the unit.

## Functional diagram

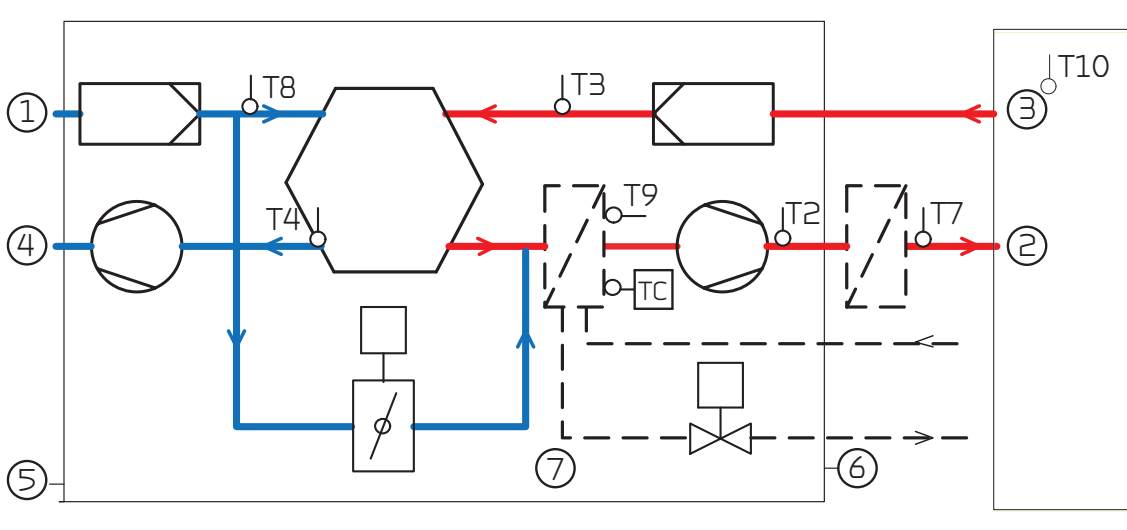

### Connections

- 1: Fresh air
- 2: Supply air
- 3: Extract air
- 4: Discharge air
- 5: Condensate drain
- 6: Electric and water heating

### Automation

- T2/T7: Supply air sensor
- T9/TC: Heating element frost protection
- T3: Extract air sensor
- T4: Discharge air and defrost sensor
- T8: Fresh air sensor
- T10: Room sensor



Functional overview		+ Standard - Accessories
3 levels	The control function is divided into 3 levels: User/Service/Factory with various options at each level	+
Weekly plan	The unit has 3 weekly programmes (with a factory setting of "off") <ul style="list-style-type: none"> <li>• Programme 1: for working families</li> <li>• Programme 2: for stay-at-home families</li> <li>• Programme 3: for businesses</li> </ul> There is also an option for you to set your own weekly programme.	+
User option 1	This allows you to override the operating mode in the main menu via an external potential-free contact or PIR sensor.	+
User option 2	With an Expansion PCB mounted, allows you to make additional connections, e.g. <ul style="list-style-type: none"> <li>• User option 2 overrides User option 1 (e.g. connecting an EM box)</li> <li>• Up to 500 W direct</li> <li>• Output relai</li> <li>• Switching the central heating system on/off</li> </ul>	-
Alarms	Alarm log featuring the last 16 alarms.	+
Datalog	Possible to log data. Kapacity 46.000 logs <ul style="list-style-type: none"> <li>• Adjustable between 1 and 120 minutes</li> <li>• If "OFF", only events and alarms are logged</li> </ul>	
Filter monitor	Filter monitor with timer (factory setting of 90 days). Adjustable to 30/90/180/360 days.	+
Bypass	Bypassing the outdoor air reduces heat recovery when heat recovery are not needed.	+
Air quality	Allows you to choose whether to switch humidity sensors and/or CO <sub>2</sub> sensors on and off.	+/-
Humidity control	Allows you to set a higher or lower ventilation step in the case of high/low air humidity.	+
CO <sub>2</sub> control	Allows you to set a higher or lower ventilation step in the case of a high CO <sub>2</sub> level.	-
Summer/Winter operation	Possible to set operation for summer and vinter	
Winter low	Allows you to select a low ventilation step in the case of low outside temperatures	+
Defrost function	Temperature-based automatic function for defrosting the heat exchanger.	+
Frostprotection	In case of failing heating system, the unit is turned off to avoid further cooling with a risk of the water heating coil frost bursting.	+
Temperature control	Allows you to select the temperature sensor which will control the unit. <ul style="list-style-type: none"> <li>• T15 ROOM (panel sensor)</li> <li>• T10 EXT (fitted in a representative extraction valve)</li> <li>• T3 EXHAUST (extract air)</li> </ul>	+
Room low	Stops the unit at a low room temperature. Hereby is cooling of the home avoided in case of a failing central heating system. Standard set to OFF. Can be set from 1 to 20 degrees and is controlled by: <ul style="list-style-type: none"> <li>• T15 ROOM (panel sensor)</li> <li>• T10 EXT (fitted in a representative extraction valve)</li> <li>• T3 EXHAUST (extract air)</li> </ul>	+
Air volume	Allows you to set four ventilation steps stepless. Supply air and extract air are set individually. Step 1 < 25% - Step 2 < 45% - Step 3 < 70% - Step 4 < 100%	+
External firealarm	Possible to connect the unit to external firealarm.	+
Joint alarm	Outlet for joint alarm	+
Constant pressure control	Allows control from both the extract air and supply air side.	-
Cooling	Via bypass (can only cool with outdoor temperature) and cool recovery (can only cool with indoor temperature). This allows you to choose whether to run the system at a higher or the highest ventilation step during cooling. The weekly programme has an option for setting cooling at night.	+
Intake air control	Allows you to set the regulator to control the intake air temperature/supply air (only available if the control unit has been configured for a supply-heating element).	+
External heating element	<ul style="list-style-type: none"> <li>• Temperature sensor T7 is an supply air sensor</li> <li>• Integrated frost protection for external water heating element</li> <li>• Motorised valve and circulation pump control unit</li> </ul>	-
External electric heating element	<ul style="list-style-type: none"> <li>• Temperature sensor T7 is an supply air sensor</li> <li>• Overheating protection</li> </ul>	-
Delayed start-up	There is a possibility for a delayed start-up by the fans, when a closing damper is installed.	+
Reset	Allows you to restore the factory settings.	+
Manual test	Allows you to test the unit's functions manually.	+
Language	Option for setting the relevant language (Danish/Finnish/Norwegian/Swedish/German/English/French).	+

# COMMUNICATION

## External communication

The CTS 602 control unit communicates by default with Modbus RTU RS485 communication. A CTS system using this form of communication can easily be connected to the unit.

Nilan units have an open Modbus communication, i.e. not only can the unit be monitored, but its operation can also be set in the same way as it can via the operating panel.

The protocol is set up by default for a Modbus RTU 30 address, but can be set to a value between 1 and 247.

A Modbus converter allows you to connect one or more units to a computer to monitor and control the unit.

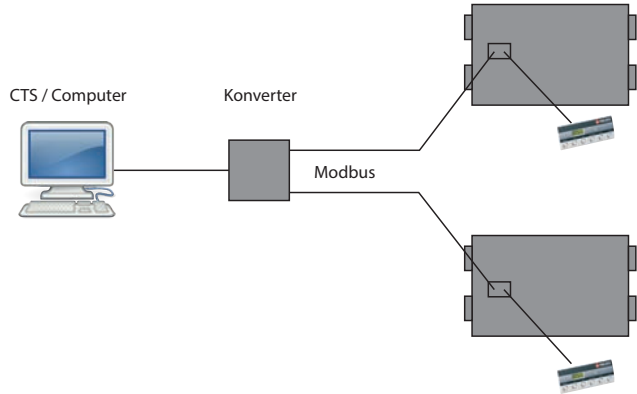

# OPERATION

## Intelligent humidity control

Nilan's humidity control automatically adapts to the needs of the family or the building.

The intelligent CTS 602 control unit does not need to have a set level input for air humidity (RH) to control the air exchange. By using the integrated humidity sensor, the control unit calculates the average level itself for the last 24 hours. The average level provides a basis for deciding whether to change the air exchange if the air humidity fluctuates.

This ensures that the unit always runs at its most efficient, based on the actual air humidity level and not on a theoretical one.

This helps save energy because it automatically adapts to the requirements in the home. Whether a large family or a single person is living in the building has a considerable influence on how much humidity is produced.

The unit also adjusts automatically to summer and winter level.

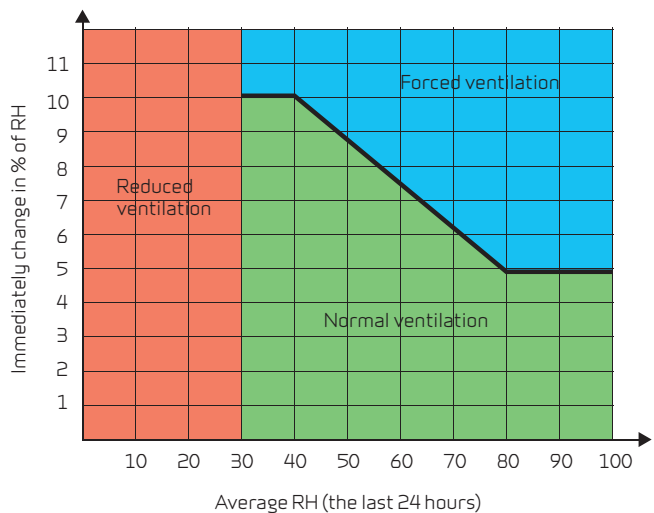

*If the air humidity changes by more than 5-10% in relation to the average level, the unit responds with a higher rate of air exchange accordingly.*

*At an air humidity below 30% is reduced ventilation step activated (adjustable between 15 and 45%)*

## Frost protection

All ventilation units with a counterflow heat exchanger will ice up if the outdoor temperature is below freezing for a prolonged period.

The extracted air condenses when it is cooled down during heat recovery. The high temperature efficiency will slowly turn the condensate to ice, which will block up the counterflow heat exchanger unless action is taken to remedy this.

Consideration must be given to whether the unit's operation can be protected during a lengthy period of frost or whether it is acceptable to decrease its operation.

In homes which are occupied at night, it would be advisable to protect the unit against frost when the outdoor temperature is coldest by using a pre-heating element. On the other hand, if the ventilation is for an office, it may be acceptable to decrease the operating level at night.

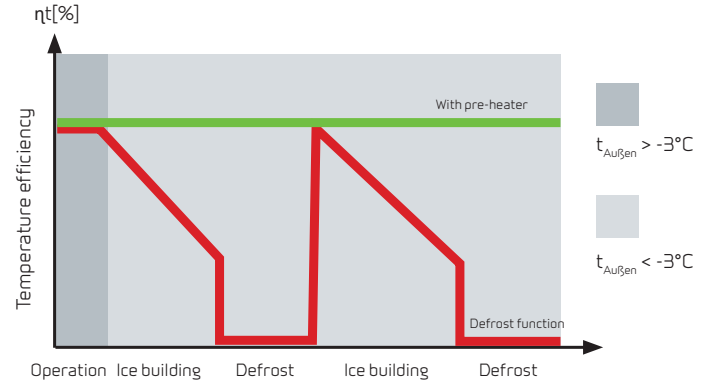

The energy used for the preheating is not wasted, as it ensures a constant high temperature efficiency

### Frost protection

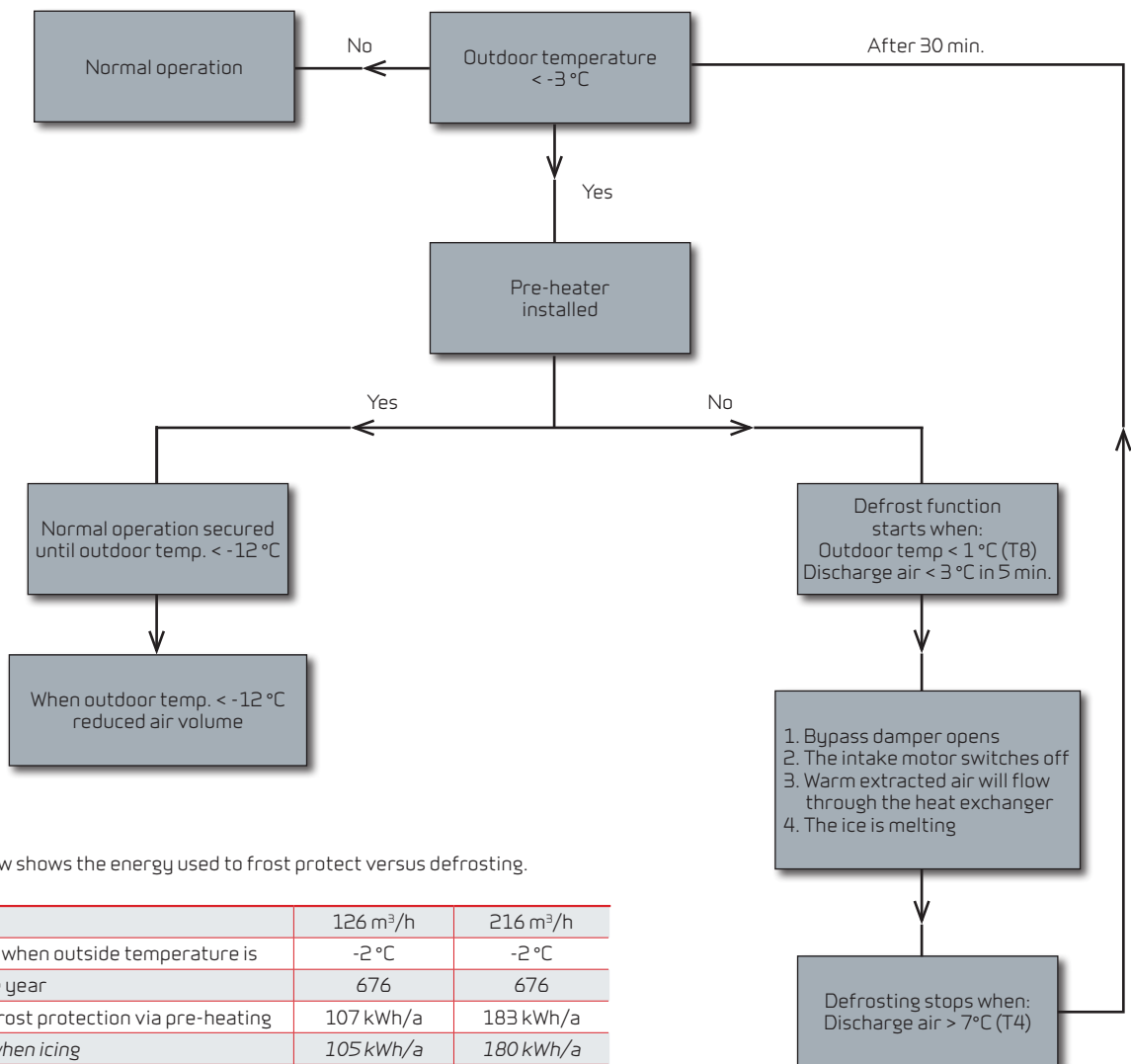

The example below shows the energy used to frost protect versus defrosting.

Air volume	126 m <sup>3</sup> /h	216 m <sup>3</sup> /h
Frost protection when outside temperature is	-2 °C	-2 °C
Hours during the year	676	676
Energy used to frost protection via pre-heating	107 kWh/a	183 kWh/a
Loss of energy when icing	105 kWh/a	180 kWh/a
Loss of energy when deicing	200 kWh/a	343 kWh/a
Energy savings by using frost protection	198 kWh/a	340 kWh/a

Average calculation by Danish dry weather data.

# ACCESSORIES



## CO<sub>2</sub>-sensor

With a CO<sub>2</sub>-sensor installed, the ventilation speed can be pre-programmed with CTS602 to run at a higher ventilation steps when CO<sub>2</sub> reaches high level in the extract air. CO<sub>2</sub>-level is programmable.

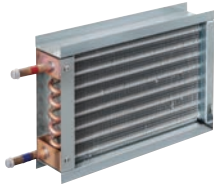

## Water heating element incl. regulation

The supply temperature can always be raised to the required level using a water heating element. The water heating element is designed to be built into the unit and must be connected to the primary heating supply. Supplied with two-way adjustment valve, temperature sensor and frost thermostat.



## Electrical heating surface incl. regulation

When you fit an electrical heating surface, you can raise the fresh air temperature to the desired level at any time. The electrical heating surface is supplied ready to fit into the fresh air duct and, for easy fitting, the device is pre-fitted with all the required sensors.



## Electrical pre-heating element (Frost protection)

An electrical pre-heating element heats up the outdoor air before it enters the unit. This avoids having to defrost the unit, resulting in a loss of power.

There are temperature sensors supplied to be fitted in the ducts.



## EM-box

An EM-box allows heat recovery from the air from the range hood and thereby helps to heat the supply air. The EM-box is equipped with a special filter which efficiently cleans the range hood air of fat particles and thereby protects the system.



## Expansion PCB

The expansion PCB provides additional functions for the CTS 602 control unit, e.g., controlling the EM box (see list of functions on page 7).



## Pollen filter F7

A pollen filter in class F7 can be fitted in the unit. The pollen filter is fitted with the G4 plate filter.

## Installation kit

The installation kit comprises of four vibration absorbers and a water trap for the condensation outlet. The water trap can be ordered separately.



## Heating cable

To protect the condensation outlet against frost, a 3 metre-long self-regulating heating cable can be ordered.

# DELIVERY AND HANDLING

## Transport and storage

Comfort 450 comes in factory packaging that protects it during transport and storage. Comfort 450 must be stored in a dry place in its original packaging until installation.

The packaging should only be removed immediately prior to installation.

## Installation conditions

During installation, future service and maintenance should be taken into account. We recommend a minimum gap in front of and behind the unit of 60 cm.

The unit must be installed level for the sake of the condensate drain. The condensate drain requires clearance of min. 12,5 cm under the drain nozzle.

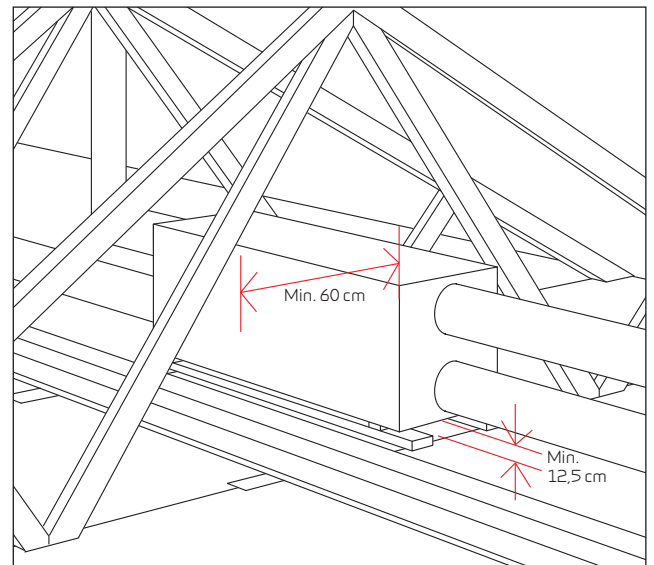

## Installation of electric heating element

Electric heating elements (accessories) are fitted in the duct. The fitter should ensure that there is a safe distance of at least 15 cm between the electric heating element and any inflammable material. The heating element must be insulated using fire-resistant insulation material.

The electric heating element must be connected by an authorised electrician.

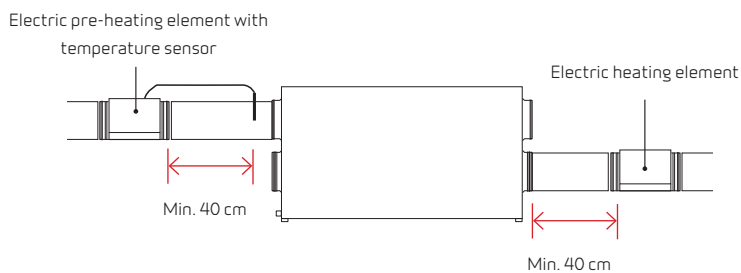
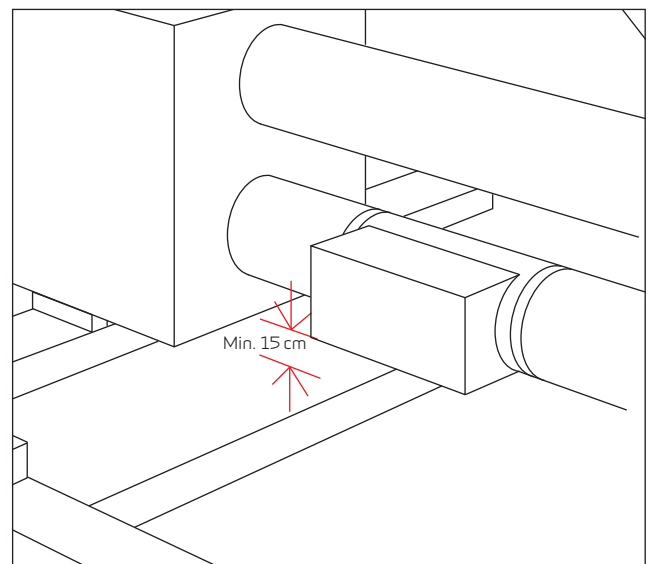

# NILAIR

NilAIR is installed together with a ventilation unit, which in simple terms consists of distribution boxes from which tubes are led out to air extraction and air supply boxes in the individual rooms.

NilAIR can be installed in ceilings, walls or floors. The lightweight tubes can be used for even the most complicated tube alignments, where e.g. traditional spiral ducts cannot be used.

## Advantages

- Flexible and space-saving solution
- Rapid and simple installation with a click system
- Dimensionally stable and corrosion-resistant quality material
- Simple regulation of the air supply volume
- Low weight
- Airtight
- Easy to clean
- Easy to handle and transport
- Prevents sound travelling from room to room

NilAIR is already installed in thousands of European homes and since its introduction more than ten years ago its use has steadily increased, due to the rapid and easy installation without any special tools being required.

## Enabling the impossible

Traditional air distribution systems take up a lot of space and often make special building structures impossible. NilAIR virtually eliminates this problem, due to the tubes' size and flexibility.

## Installation examples



## Air extraction (mounted in wall or ceiling)

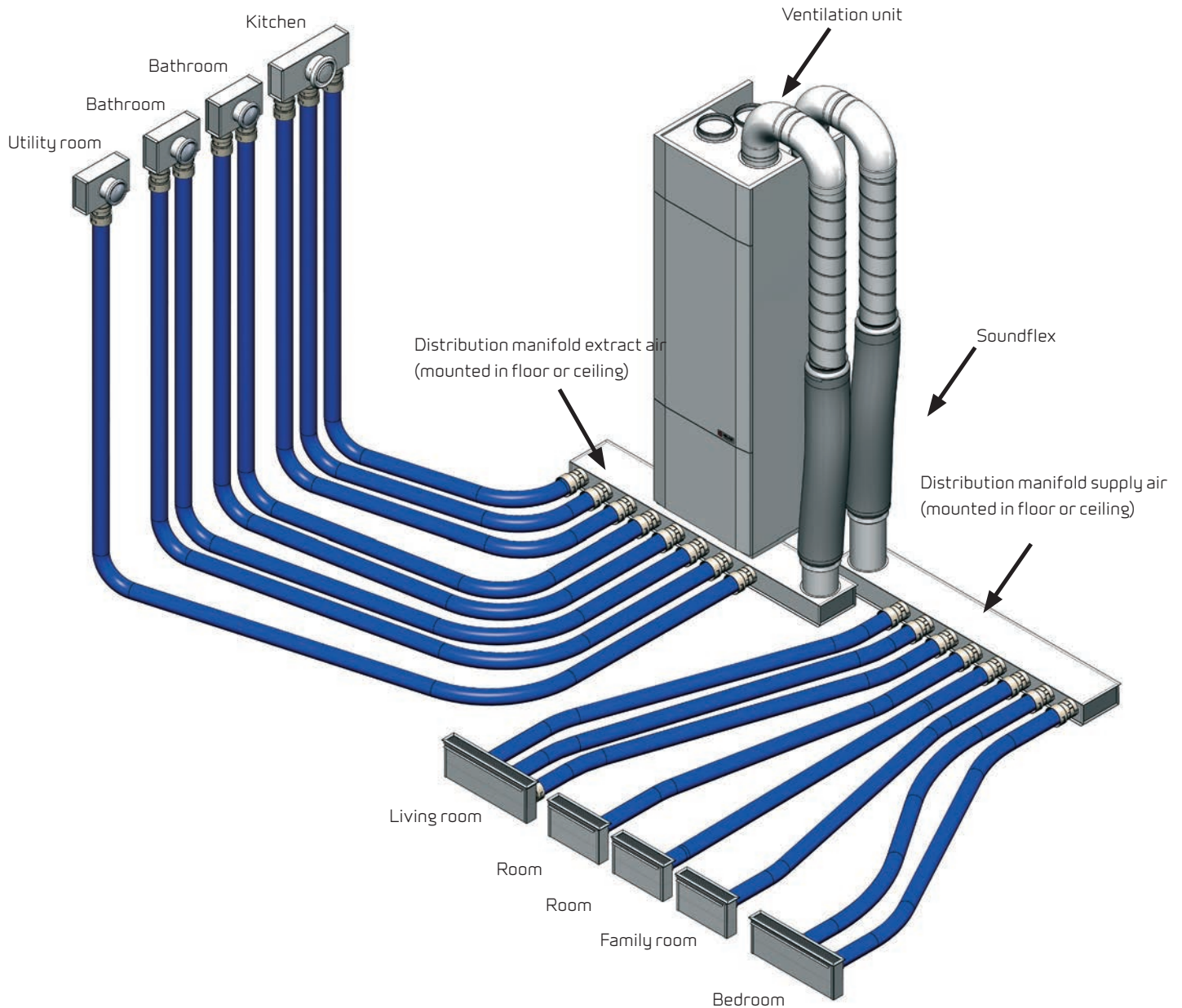

## Air supply (mounted in floor, wall or ceiling)

# INFORMATION FROM A TO Z

Nilan develops and manufactures premium-quality, energy-saving ventilation and heat pump solutions that provide a healthy indoor climate and low-level energy consumption with the greatest consideration for the environment. In order to facilitate each step in the construction process - from choosing the solution through to planning, installation and maintenance - we have created a series of information material which is available for download at [www.nilan.dk](http://www.nilan.dk).



**Brochure**  
General information about the solution and its benefits.



**Product data**  
Technical information to ensure correct choice of solution.



**Installation instructions**  
Detailed guide for installation and initial adjustment of the solution.



**User manual**  
Detailed guide for regulation of the solution to ensure optimum day-to-day operation.

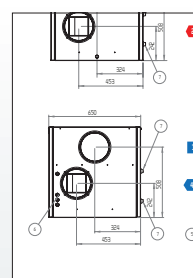

**Drawings**  
Tender documents and 3D drawings are available to download for planning purposes.

[WWW.NILAN.DK](http://WWW.NILAN.DK)

Visit us at [www.nilan.dk](http://www.nilan.dk) to find out more about our company and solutions, download further information and find your nearest dealer.



Nilan A/S  
Nilanvej 2  
8722 Hedensted  
Denmark  
Tel. +45 76 75 25 00  
Fax +45 76 75 25 25  
[nilan@nilan.dk](mailto:nilan@nilan.dk)  
[www.nilan.dk](http://www.nilan.dk)