

PRODUCT DATA

COMPACTS BY NILAN



Domestic



Passive
heat recovery



Active
heat recovery



Ventilation
< 375 m³/h



Comfort
heating



Comfort
cooling



Sanitary
hot water
production

COMPACT S

Product description

Compact S is an energy-efficient total indoor climate solution for all types of low-energy buildings, single-family homes, flats and small office areas in commercial leases with a ventilation requirement of up to 375 m³/h.

Compact S recovers the energy from the extracted air using a highly efficient counter flow heat exchanger. The remaining energy that is not utilised by the counter flow heat exchanger is used by the heat pump to produce hot water, and to further heat the supply air.

The heat pump has a reversible cooling circuit, which means that, in the summer, the unit can cool the supply air by up to 10 °C. Due to the low air exchange, the cooling does not function as an air conditioning system. On cooling, the supply air is dehumidified, which gives a more pleasant indoor climate than is possible with an ordinary ventilation unit without a heat pump.



Future-proof system

Compact S hot water production fulfils the most stringent requirements in the ecodesign regulation and thereby achieves the highest energy labelling.

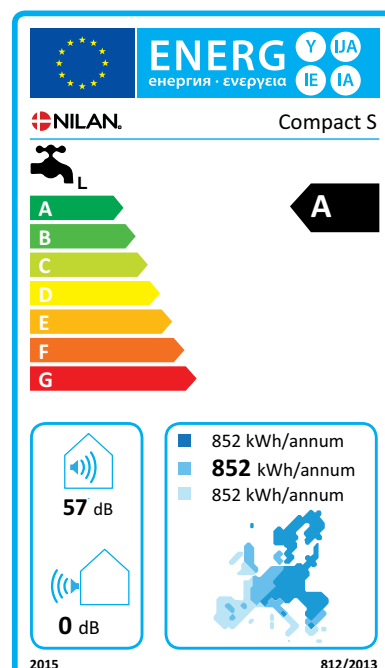

Time-controlled filter change alarm.
Easy filter access by opening the top front panel with the help of two finger screws.

There is plenty of space to replace filters and to vacuum clean the filter space.

8 duct connections.
Compact S is supplied as standard with 4 duct connections in the top.

Plates are mounted on the side, which makes it possible to move the ducts from the top to the side as required.



A clear, user-friendly operating panel with help texts is included.

The modern CTS 602 control runs Modbus communication.

Heating pump with hermetically sealed cooling circuit, for production of hot water and active heat recovery. Can raise the air intake temperature up to 34 °C.

Reversible cooling circuit that can also cool the air intake in the summer up to 10 °C, with simultaneous hot water production.

180 l hot water tank.
2 layers of glass enamelling to ensure a long lifetime.

Electrically monitored sacrificial anode and corrosion protection.

On any need for replacement, an alarm is activated in the operating panel.

Attractive white-painted front with large front panels, giving easy access to service the system.

Counterflow heat exchanger in polystyrene, with a temperature efficiency ratio of up to 86 %.

Automatic bypass function that carries the air past the counterflow heat exchanger when heat recovery is not required.

A powder-coated condensation tray prevents the formation of "acid water", leading out the condensation water.

Compact P has an integrated water lock.

Intelligent moisture control.
Adapts ventilation to the home's current humidity level. See page 14.

CO₂-sensor can be purchased, for further demand management.

The efficient fans are powered by energy-saving EC motors.

The hot water tank is foam-insulated, giving good insulation and saving energy.

1.5 kW electrical completion.
For high hot water consumption where the heating pump cannot cope.

Automatic anti-legionella.

Compact S can be supplied with built-in solar coil.

The solar coil is intended for solar heating with solar panels of about 0.6 m².

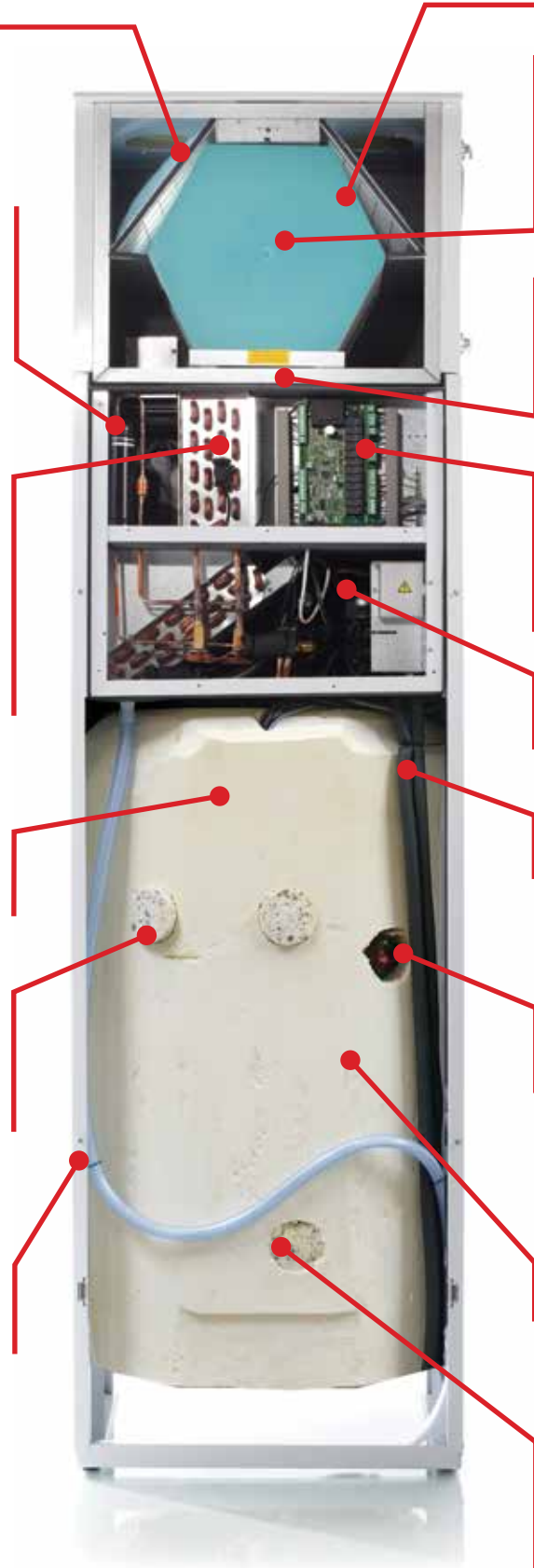

TECHNICAL DATA

Technical specifications

Dimensions (W x D x H)	600 x 600 x 2250 mm
Weight	160 kg
Plate type casing	Aluzinc steel plate, white powder coating RAL9016
Heat exchanger type	Polystyrene counterflow heat exchanger
Fan type	EC, constant rotation
Filter class	Standard G4
Duct connections	Ø 160 mm
Condensate drain	PVC, Ø 20x1,5 mm
Refrigerant	R134a
Refrigerant filling	2.25 kg
Capacity SHW tank	180 l
Supplementary electrical heating (sanitary hot water)	1.5 kW
Connection dimension	3/4"

Supply voltage	230 V (±10 %), 50/60 HZ
Max. input/power (*1)	2,2 kW/ 9,6 A
Max. input/power (*2)	2,8 kW/12,2 A
Tightness class	IP31
Standby power	3 W
Ambient temperature	-20/+40 °C
Power consumption build-in preheating element (Polar)	600 W
External leakage (*3)	< 0.79%
Internal leakage (*3)	< 1.47%

*1 Input without heating element (accessory).

*2 Input Compact Polar

*3 At ± 250 Pa and 265 m³/h according EN 13141-7.

*4 At ± 100 Pa and 265 m³/h according EN 13141-7.

Hot water production

Consumer profile, water heater	L (large)
Energy efficiency class	A
Energy efficiency for water heating - average climate	118 %
Annual electricity consumption - average climate	852 kWh/annum
Temperature settings on the thermostat	10 - 65 °C
Sound power level L _{WA}	57 dB(A)
The water heater can function outside peak load periods (Smart-grid)	No
Guidelines for assembly, installation and maintenance	See installation instructions
Energy efficiency for water heating - cold climate	118%
Energy efficiency for water heating - warm climate	118%
Annual electricity production - cold climate	852 kWh/annum
Annual electricity consumption - warm climate	852 kWh/annum

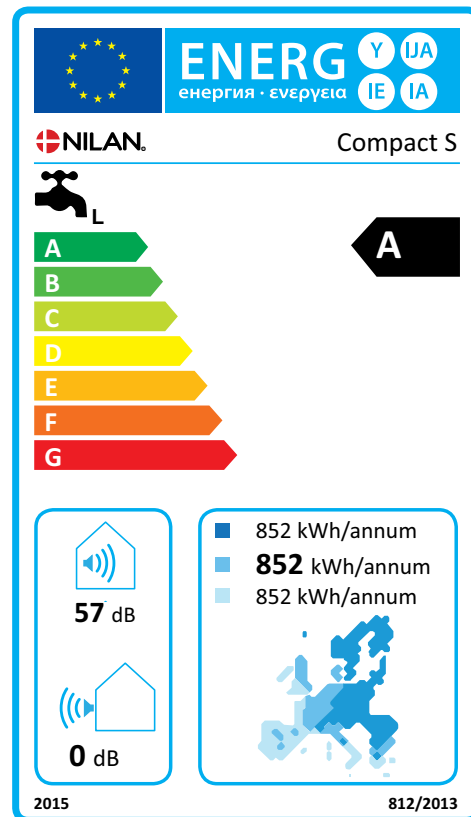

Dimensional drawing

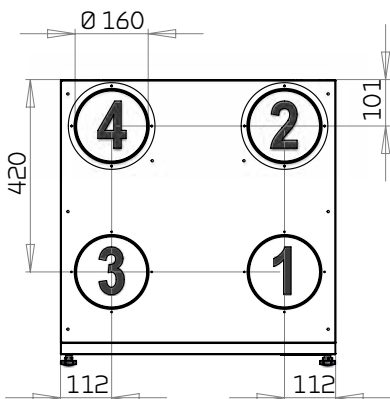
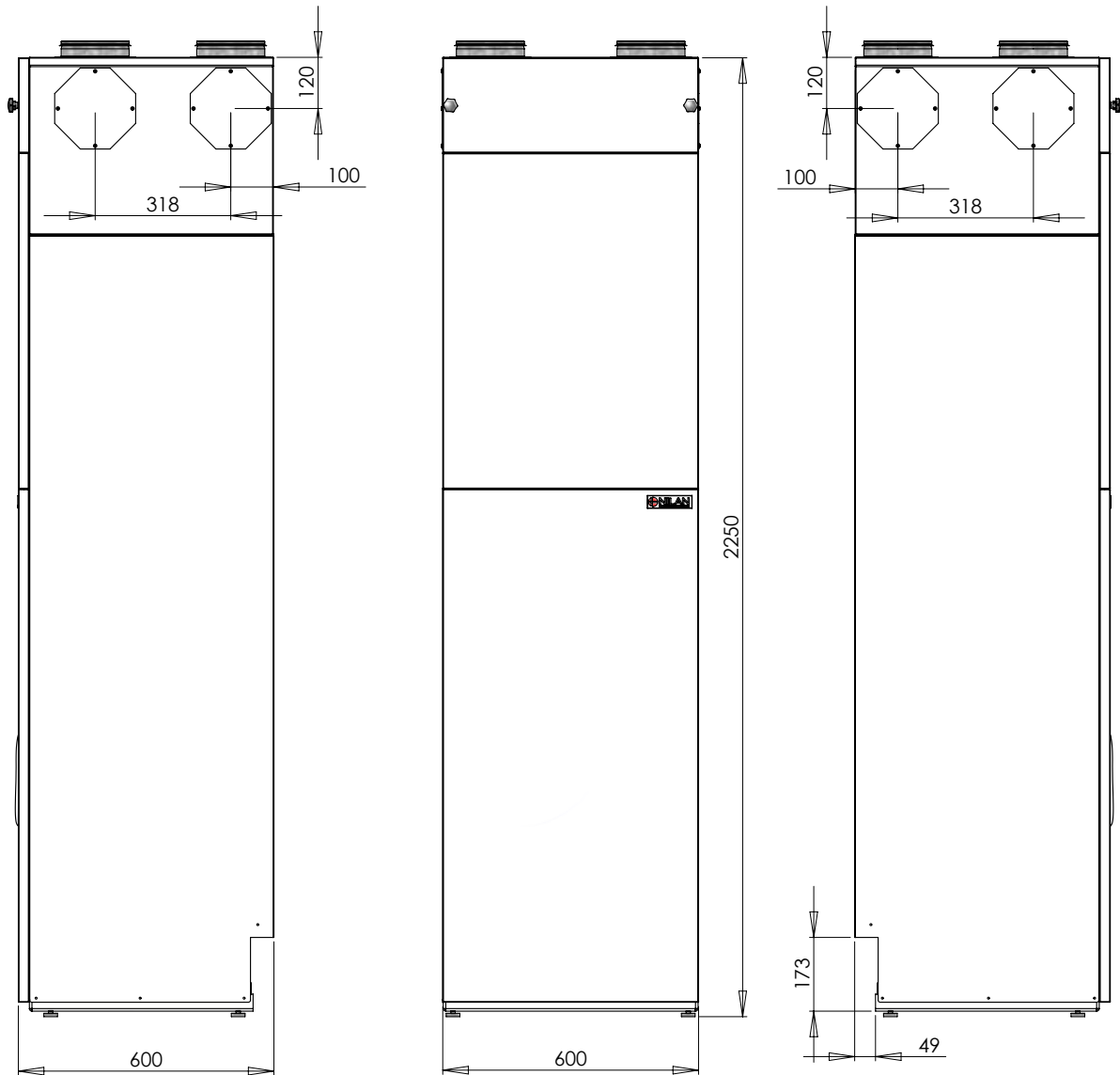

Connections

- 1: Fresh air
- 2: Supply air
- 3: Extract air
- 4: Discharge air

MULTI-FUNCTIONAL



100 % heat recovery

Compact S ventilates the home, ensuring a good indoor climate. While also producing hot water.

Compact S is an untraditional ventilation unit that, in contrast to other ventilation units, recovers 100% of the heat in the extracted air.

Via a counter flow heat exchanger, up to 95 % of the energy in the extracted air is used to heat the supply air.

The built-in heat pump uses the remaining energy to further heat the supply air, while also producing hot water.

Cooling the home is the challenge of the future

New homes are well-insulated and therefore easy to heat. On the other hand, outdoor temperatures do not need to be very high before getting rid of the heat in the home becomes problematic.

Compact S has a reversible cooling circuit, to cool the supply air. Due to the low air exchange, it will not function as an air conditioning system. When cooling the supply air will be dehumidified, which contributing to a pleasant climate in the home.

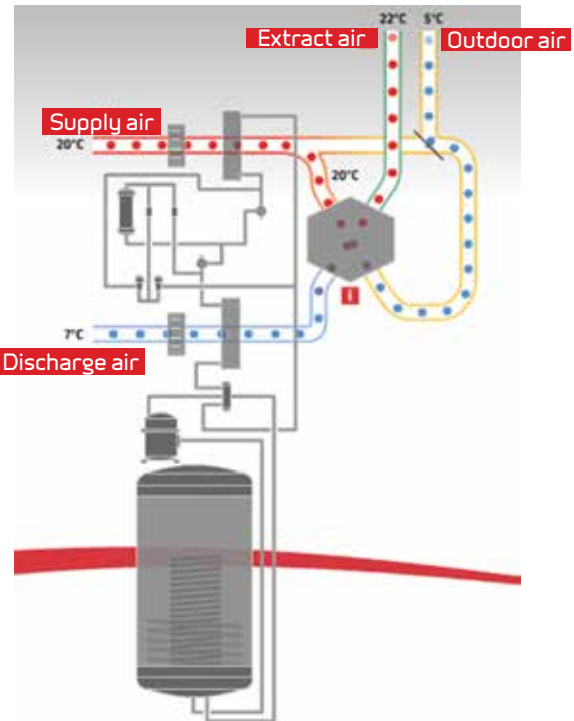

Passive heat recovery

Passive heat recovery takes place via a counter flow heat exchanger with a high temperature efficiency, whereby the supply air is heated by the extracted air.

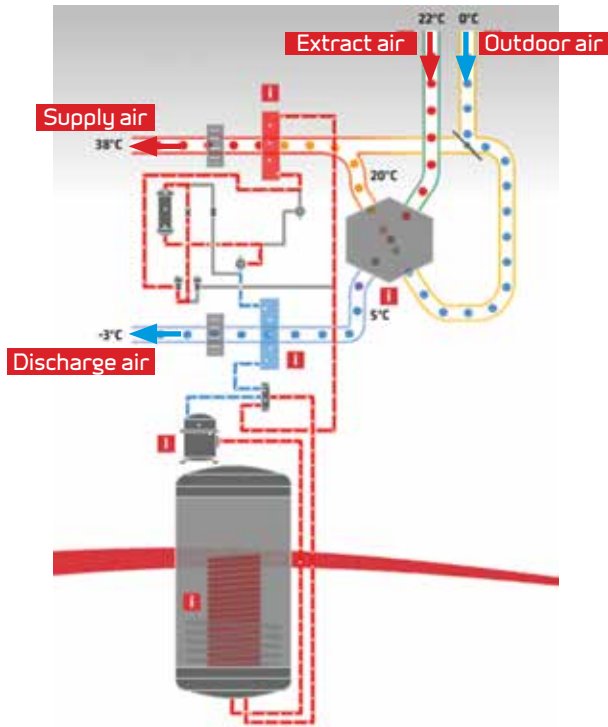

Passive and active heat recovery
 Utilising the residual energy that the counterflow heat exchanger does not use, the heat pump further heats the supply air.

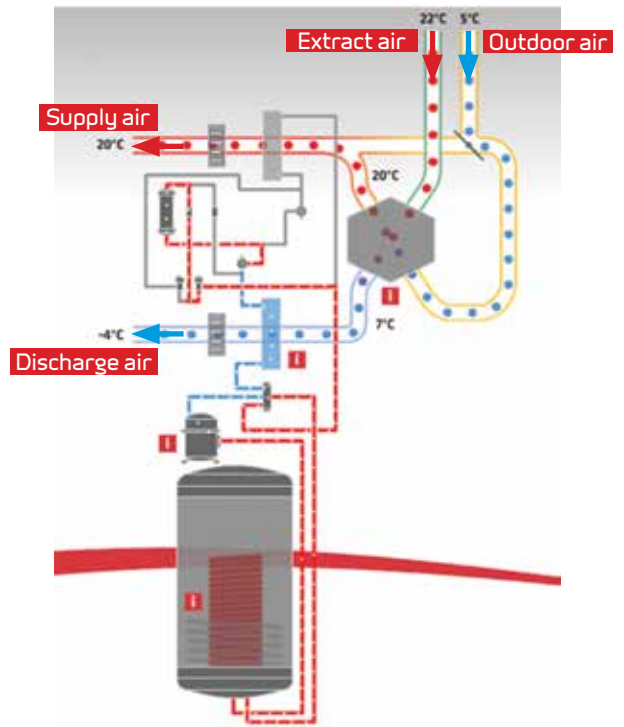

Hot water
 Utilising the residual energy that the counterflow heat exchanger does not use, the heat pump produces hot water.

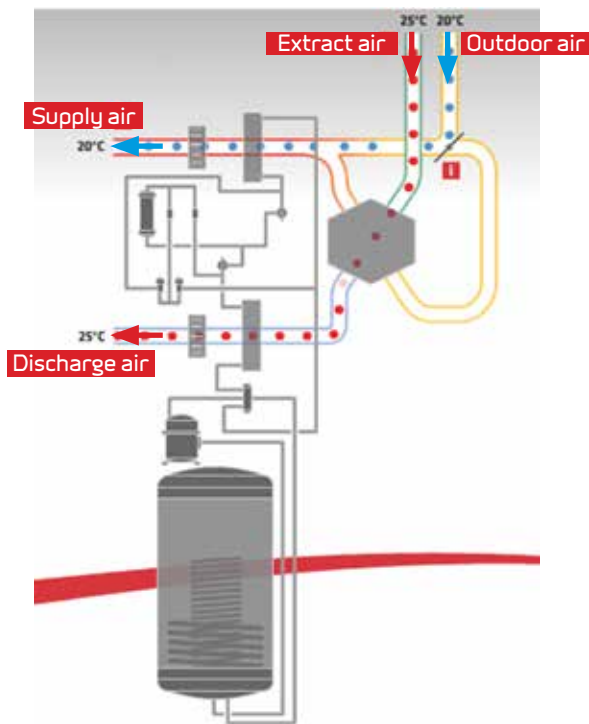

100% bypass function
 If heat recovery is not required, the bypass damper closes off 100% and leads the outdoor air past the heat exchanger.
 Hot water can be produced at the same time. Hot water is produced with a high efficiency (COP).

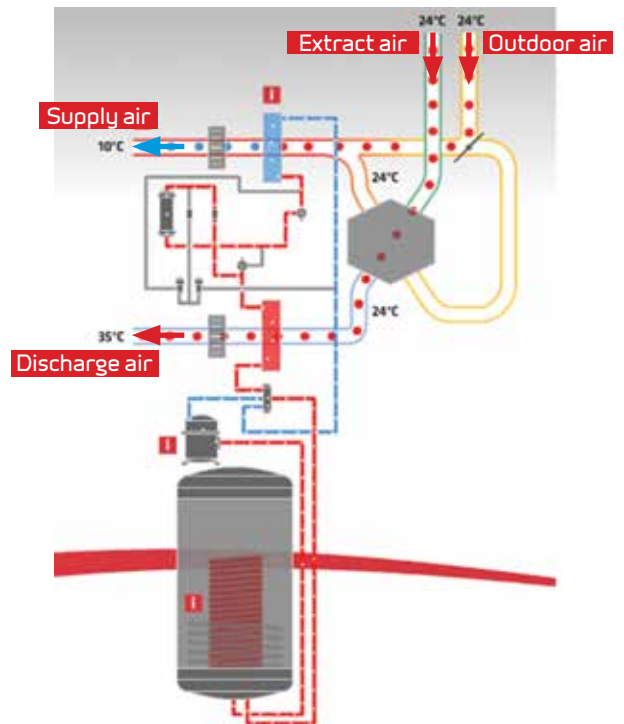

Active cooling
 The heat pump has a reversible cooling circuit and can cool the supply air during hot periods.
 This function does not affect the production of hot water, which takes place with high efficiency (COP).

PLANNING DATA

Capacity

Capacity of standard unit as a function of q_v and $P_{t,ext}$.

SEL values according to EN 13141-7 are for standard units with G4 filters and without heating element.

SEL values comprise the unit's total power consumption incl. control.

Conversion factor: $\frac{J/m^3}{3600} = W/m^3/h$

Attention! The SEL values are measured and stated as a total value for both fans.

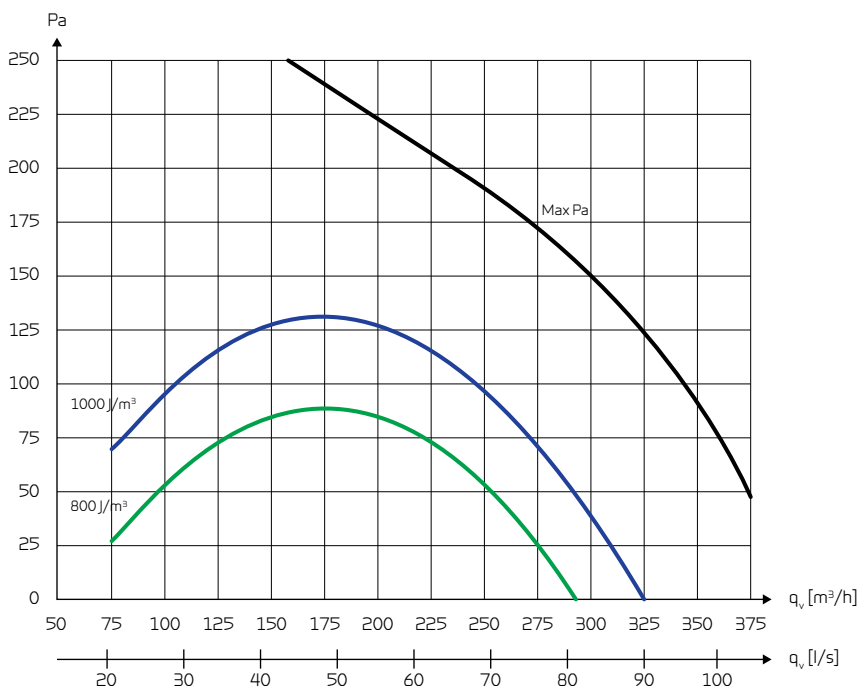

Temperature efficiency

Temperature efficiency for units with counterflow heat exchanger according to EN13141-7

NB! Temperature efficiency is only for the counter flow heat exchanger (without heat pump operation)

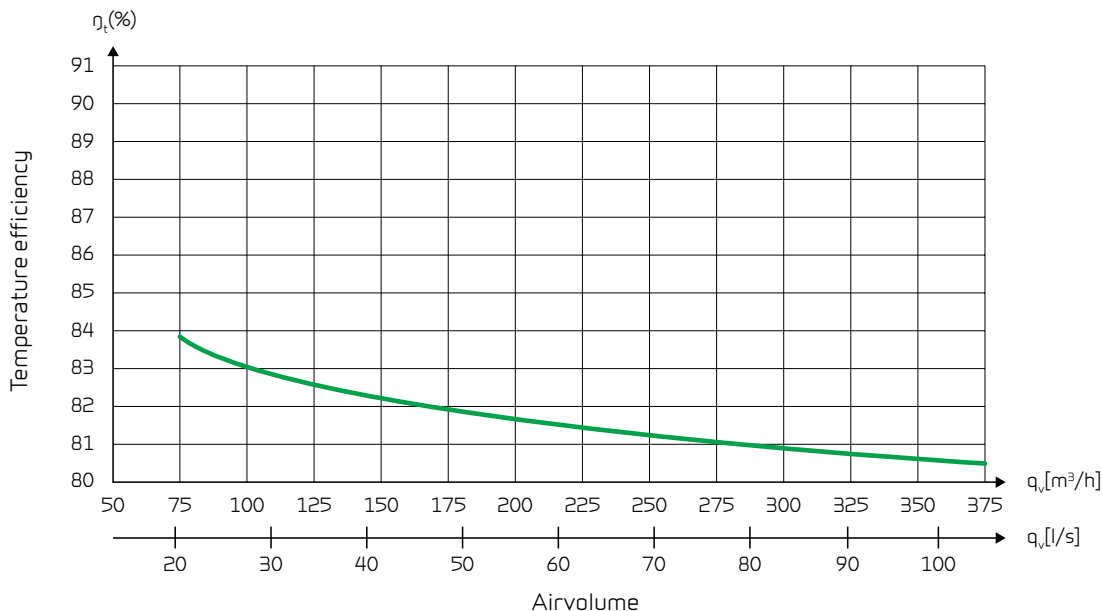

Heat output supply air

Heat output Q_c [W] as a function of q_v [m³/h] and outdoor air temperature t_{21} [°C]. In accordance with EN 14511, $t_{11}=21^\circ\text{C}$ (extract air)
 Heat output is the contribution to room heating added to the fresh air via Compact S to the supply air.
 The ventilation loss is the heat output that is lost without heat recovery at the given volume flow air.

COP (air-air)

Heat output factor COP [-] supply air as a function of outdoor temperature t_{21} [°C] and volume flow q_v [m³/h] in accordance with EN14511 at a room temperature $t_{11} = 21^\circ\text{C}$

COP according EN14511 is calculated for the heat pump and counter flow heat exchanger combined.

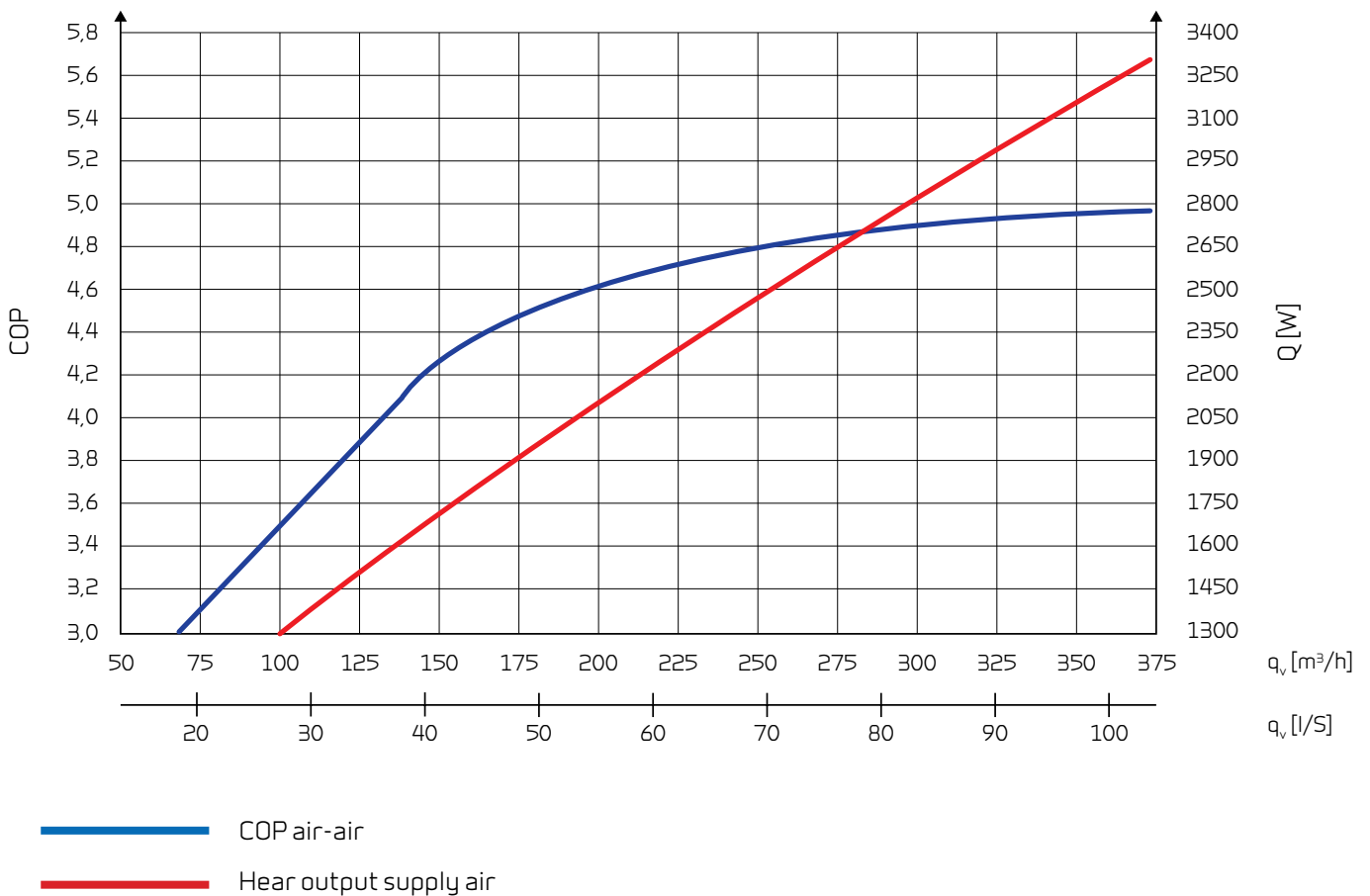

PLANNING DATA

Tapped water

Tapped volume in liters V_{\max} [L] from Compact S tank as a function of tapped temperature t [°C] and tank temperature at 40°, 50° and 60°C

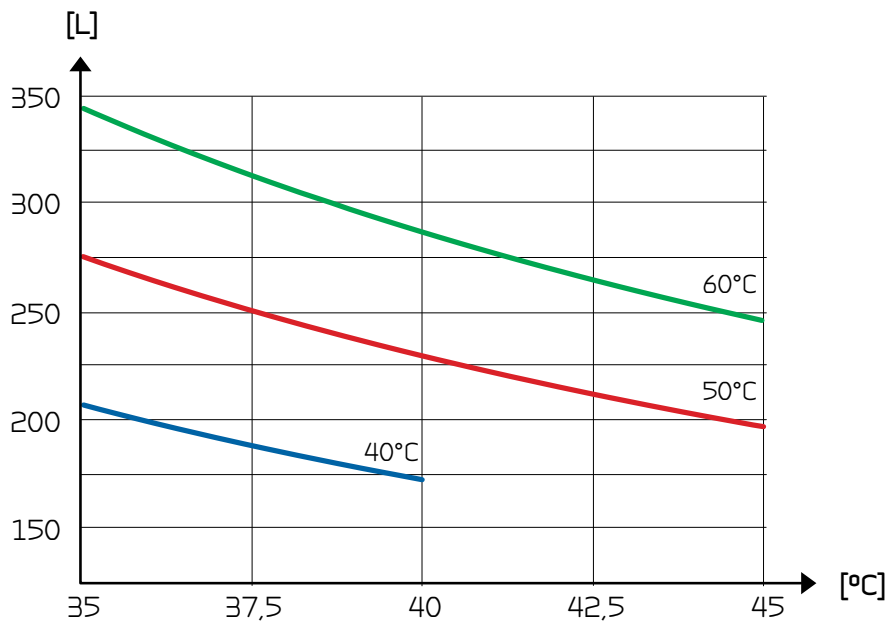

Sound data

Sound data is for $q_v = 210 \text{ m}^3/\text{h}$ and $P_{t, \text{ext}} = 100 \text{ Pa}$ in accordance with EN 9614-2 for surface and EN 5136 for ducts.

Sound output level L_{WA} drops with falling air volumes and falling back-pressure.

At a given distance, the sound pressure level L_{pA} will depend on the acoustic conditions at the installation site.

Sound output level (L_{wa})

Octave band Hz	Surface dB(A)	Supply air dB(A)	Extract air dB(A)
63	-	51	38
125	-	59	46
250	-	66	51
500	-	61	41
1.000	-	56	31
2.000	-	54	28
4.000	-	47	20
8.000	-	40	13
Total ± 2	57	69	53

AUTOMATIK

CTS 602 Control



The Compact S is controlled using its CTS602 operating panel, featuring a wide range of functions, e.g., menu-controlled operation, weekly programme settings, filter monitor with timer, fan speed adjustment, summer bypass (free cooling), supply-heating element control, error messages etc.

The CTS602 comes with factory settings, including a default setting which can be customised to operational requirements to achieve optimum operation and utilisation of the system.

The operating panel must be placed in a dry, frost-free location, at least 1.5 m above floor level and at least 0.5 m from any corner. Avoid placing the panel on an external wall or in areas in direct sunlight.

Operating instructions for the CTS 602 can be found in a separate user manual supplied with the unit.

External communication

The CTS 602 control unit communicates by default with Modbus RTU RS485 communication. A CTS system using this form of communication can easily be connected to the unit.

Nilan units have an open Modbus communication, i.e. not only can the unit be monitored, but its operation can also be set in the same way as it can via the operating panel.

The protocol is set up by default for a Modbus RTU 30 address, but can be set to a value between 1 and 247.

A Modbus converter allows you to connect one or more units to a computer to monitor and control the unit.

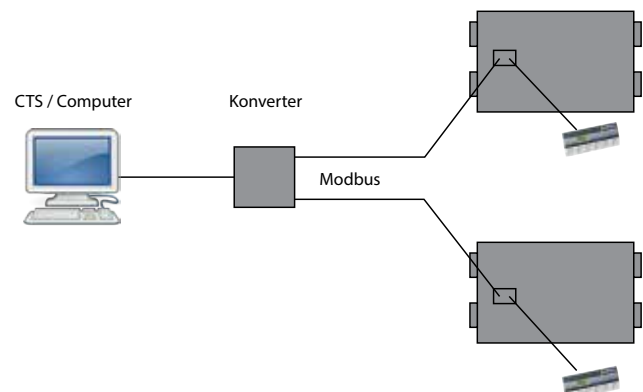

Functional overview		+ Standard - Accessories
3 levels	The control function is divided into 3 levels: User/Service/Factory with various options at each level	+
Weekly plan	The unit has 3 weekly programmes (with a factory setting of "off") <ul style="list-style-type: none"> • Programme 1: for working families • Programme 2: for stay-at-home families • Programme 3: for businesses There is also an option for you to set your own weekly programme.	+
User option 1	This allows you to override the operating mode in the main menu via an external potential-free contact or PIR sensor.	+
User option 2	With an Expansion PCB mounted, allows you to make additional connections, e.g. <ul style="list-style-type: none"> • User option 2 overrides User option 1 (e.g. connecting an EM box) • Up to 500 W direct • Output relai • Switching the central heating system on/off 	-
Alarms	Alarm log featuring the last 16 alarms.	+
Datalog	Possible to log data. Kapacity 46.000 logs <ul style="list-style-type: none"> • Adjustable between 1 and 120 minutes • If "OFF", only events and alarms are logged 	
Filter monitor	Filter monitor with timer (factory setting of 90 days). Adjustable to 30/90/180/360 days.	+
Bypass	Bypassing the outdoor air reduces heat recovery when heat recovery are not needed.	+
Air quality	Allows you to choose whether to switch humidity sensors and/or CO ₂ sensors on and off.	+/-
Humidity control	Allows you to set a higher or lower ventilation step in the case of high/low air humidity.	+
Summer/Winter operation	Possible to set operation for summer and winter	
Winter low	Allows you to select a low ventilation step in the case of low outside temperatures	+
Defrost function	Temperature-based automatic function for defrosting the heat exchanger.	+
Frostprotection	In case of failing heating system, the unit is turned off to avoid further cooling with a risk of the water heating coil frost bursting.	+
Temperature control	Allows you to select the temperature sensor which will control the unit. <ul style="list-style-type: none"> • T15 ROOM (panel sensor) • T10 EXT (fitted in a representative extraction valve) • T3 EXHAUST (extract air) 	+
Room low	Stops the unit at a low room temperature. Hereby is cooling of the home avoided in case of a failing central heating system. Standard set to OFF. Can be set from 1 to 20 degrees and is controlled by: <ul style="list-style-type: none"> • T15 ROOM (panel sensor) • T10 EXT (fitted in a representative extraction valve) • T3 EXHAUST (extract air) 	+
Air volume	Allows you to set four ventilation steps stepless. Supply air and extract air are set individually. Step 1 < 25% - Step 2 < 45% - Step 3 < 70% - Step 4 < 100%	+
Legionella control	It is possible to choose a weekday or a day during the month, where the sanitary hot water temperature reaches 65 °C, for example between 1 and 6 o' clock.	+
External firealarm	Possible to connect the unit to external firealarm.	+
Joint alarm	Outlet for joint alarm	+
Constant pressure control	Allows control from both the extract air and supply air side.	-
Cooling	Via bypass (can only cool with outdoor temperature) and cool recovery (can only cool with indoor temperature). This allows you to choose whether to run the system at a higher or the highest ventilation step during cooling. The weekly programme has an option for setting cooling at night.	+
Intake air control	Allows you to set the regulator to control the intake air temperature/supply air (only available if the control unit has been configured for a supply-heating element).	+
External heating element	<ul style="list-style-type: none"> • Temperature sensor T7 is an supply air sensor • Integrated frost protection for external water heating element • Motorised valve and circulation pump control unit 	-
External electric heating element	<ul style="list-style-type: none"> • Temperature sensor T7 is an supply air sensor • Overheating protection 	-
Delayed start-up	There is a possibility for a delayed start-up by the fans, when a closing damper is installed.	+
Reset	Allows you to restore the factory settings.	+
Manual test	Allows you to test the unit's functions manually.	+
Language	Option for setting the relevant language (Danish/Finnish/Norwegian/Swedish/German/English/French).	+

OPERATION

Intelligent humidity control

Nilan's humidity control feature automatically adapts to the needs of the family or the building.

The intelligent CTS 602 control unit does not need to have a set level input for air humidity (RH) to control the air exchange. By using the integrated humidity sensor, the control unit calculates the average level itself for the last 24 hours. The average level provides a basis for deciding whether to change the air exchange if the air humidity fluctuates.

This ensures that the unit always runs at its most efficient, based on the actual air humidity level and not on a theoretical one.

This helps save energy because it automatically adapts to the requirements in the home. Whether a large family or a single person is living in the building has a considerable influence on how much humidity is produced.

The unit also adjusts automatically to summer and winter level.

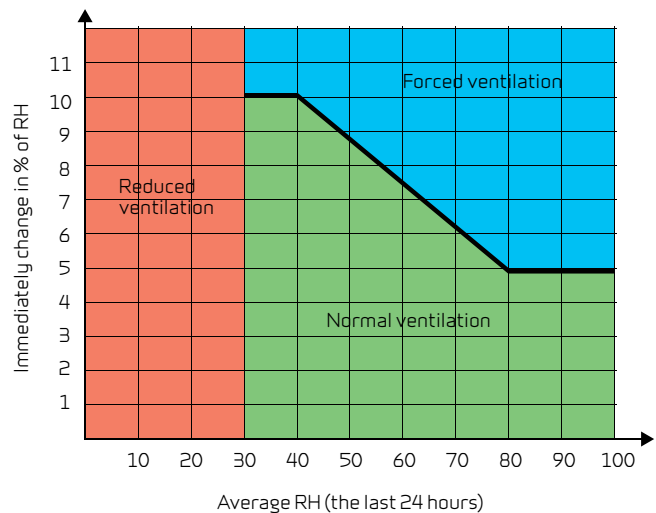

If the air humidity changes by more than 5-10% in relation to the average level, the unit responds with a higher rate of air exchange accordingly.

At an air humidity below 30% is reduced ventilation stp activated (adjustable between 15 and 45%)

Frost protection

All ventilation units with a counterflow heat exchanger will ice up if the outdoor temperature is below freezing for a prolonged period.

The extracted air condenses when it is cooled down during heat recovery. The high temperature efficiency will slowly turn the condensate to ice, which will block up the counterflow heat exchanger unless remedial action is taken.

It should be considered whether the unit's operation can be protected during a lengthy period of frost or whether it is acceptable to decrease its operation.

In homes which are occupied at night, it would be advisable to protect the unit against frost when the outdoor temperature is coldest by using a pre-heating element. On the other hand, if the ventilation is for an office, it may be acceptable to decrease the operating level at night.

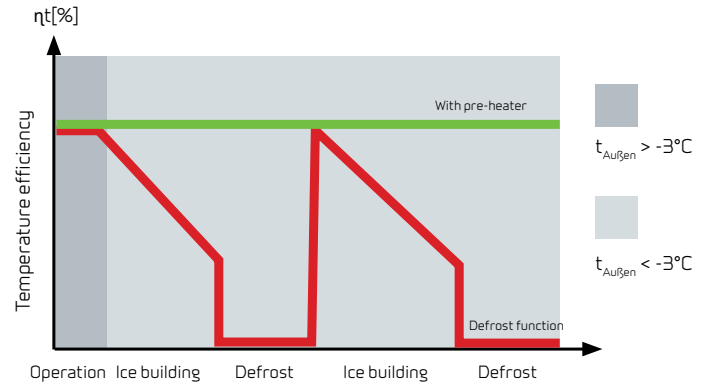

The energy used for the preheating is not wasted, as it ensures a constant high temperature efficiency

Frost protection

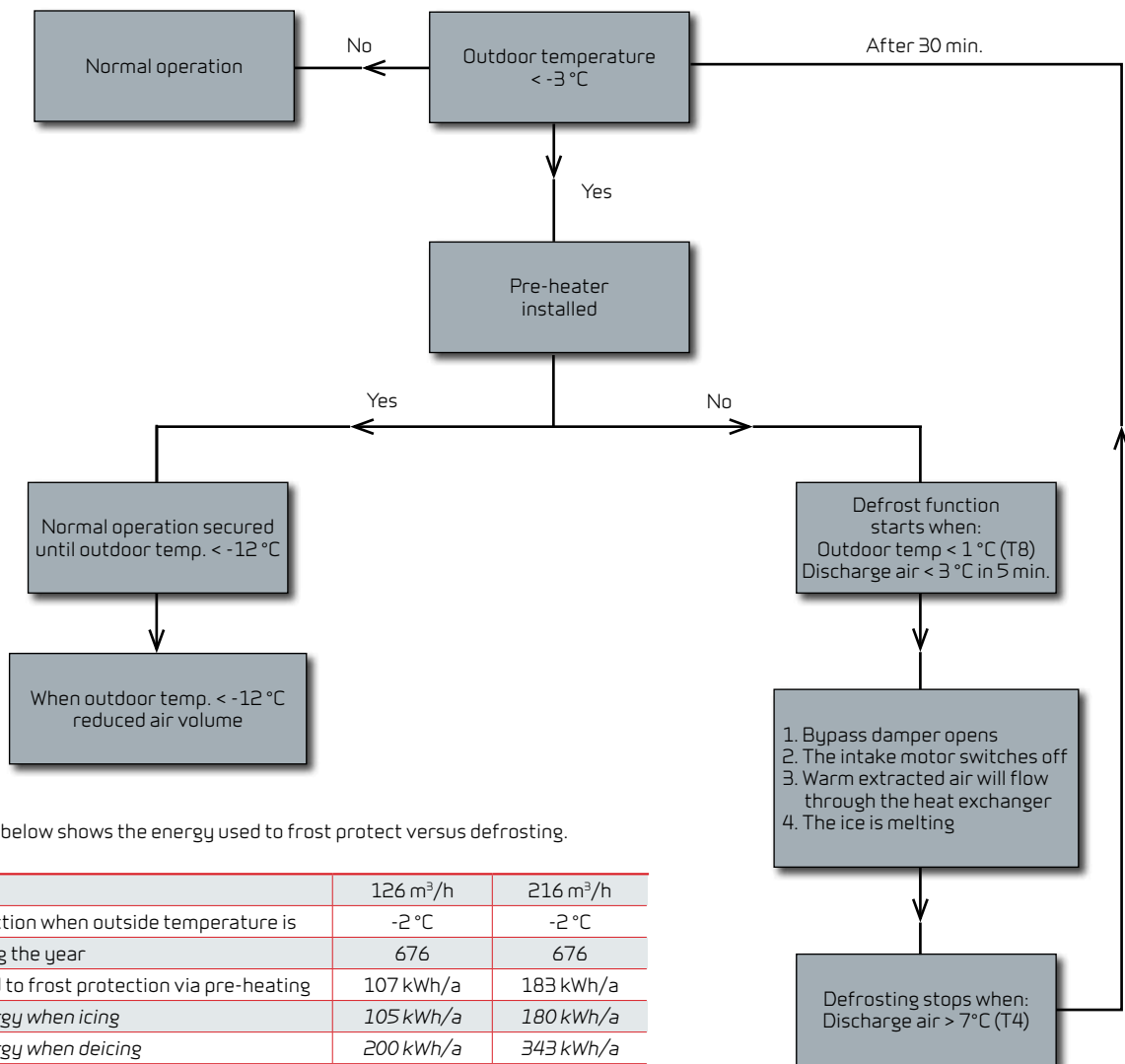

The example below shows the energy used to frost protect versus defrosting.

Air volume	126 m ³ /h	216 m ³ /h
Frost protection when outside temperature is	-2°C	-2°C
Hours during the year	676	676
Energy used to frost protection via pre-heating	107 kWh/a	183 kWh/a
Loss of energy when icing	105 kWh/a	180 kWh/a
Loss of energy when deicing	200 kWh/a	343 kWh/a
Energy savings by using frost protection	198 kWh/a	340 kWh/a

Average calculation by Danish dry weather data.

ACCESSORIES



Electrical pre-heating element (Frost protection)

To prevent the highly efficient counterflow heat exchanger from freezing, we recommend that you fit an electrical pre-heating element. The element consumes very little energy but improves heat recovery. The net result is more cost-efficient operation.



Water heating element incl. regulation

The supply temperature can always be raised to the required level using a water heating element. The water heating element is designed to be built into the duct and must be connected to the primary heating supply. Supplied with two-way adjustment valve, temperature sensor and frost thermostat.



Electrical heating surface incl. regulation

When you fit an electrical heating surface, you can raise the fresh air temperature to the desired level at any time. The electrical heating surface is supplied ready to fit into the fresh air duct and, for easy fitting, the device is pre-fitted with all the required sensors.



EM-Box

The EM-Box distributes extract air between kitchen and bathroom. If the range hood runs via the ventilation system and is operating, extract air flow from the bathroom is reduced to ensure that there is enough air to allow the cooker hood to extract cooking odours. To protect the system, the EM-box is fitted with a metal filter, which efficiently eliminates fat particles from range hood air.



DBTU damper

If there is not enough space to fit an EM-box, Nilan offers a DTBU damper, which can be fitted between kitchen and bathroom. The damper functions precisely like the EM-box but requires longer cables.



Expansion PCB

The expansion PCB provides additional functions for the CTS 602 control unit, e.g., controlling the EM box.



Pollenfilter F7

Compact S are as standard with G4 filter delivered. If there are someone in the housing which suffers of pollen allergy, it is possible to order a F7 pollenfilter to minimize the amount of Pollen in the supply-air.



Noise-attenuating flexible hose

For easy fitting and excellent noise attenuation between the system and the distribution box and/or between the system and roof vents.

NILAIR

NiLAIr is installed together with a ventilation unit, which in simple terms consists of distribution boxes from which tubes are led out to air extraction and air supply boxes in the individual rooms.

NiLAIr can be installed in ceilings, walls or floors. The lightweight tubes can be used for even the most complicated tube alignments, where e.g. traditional spiral ducts cannot be used.

Advantages

- Flexible and space-saving solution
- Rapid and simple installation with a click system
- Dimensionally stable and corrosion-resistant quality material
- Simple regulation of the air supply volume
- Low weight
- Airtight
- Easy to clean
- Easy to handle and transport
- Prevents sound travelling from room to room

Air extraction

(mounted in wall or ceiling)

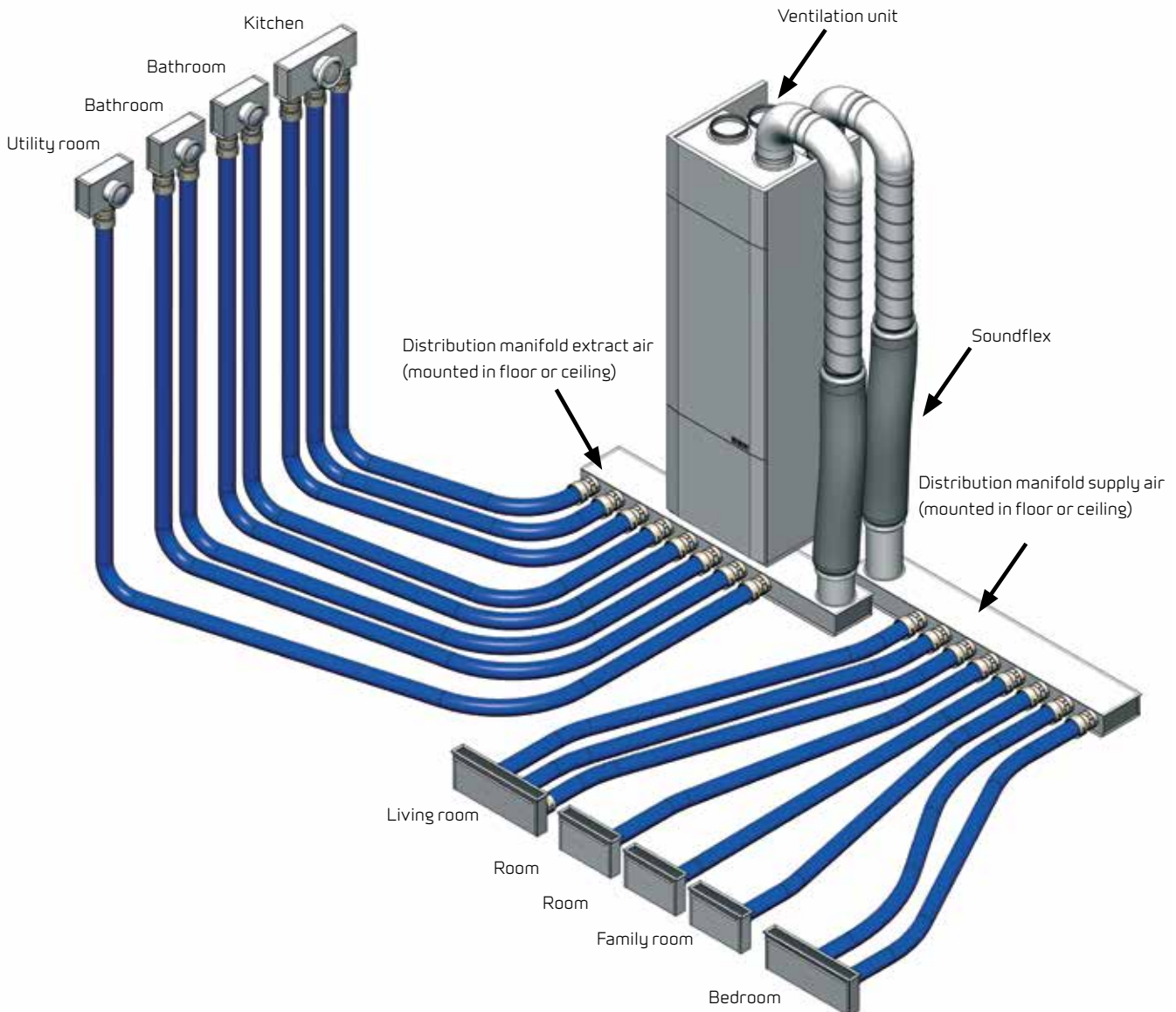

Air supply

(mounted in floor, wall or ceiling)

DELIVERY AND HANDLING

Transport and storage

Compact S comes in factory packaging that protects it during transport and storage.

Compact S must be stored in a dry place in its original packaging until installation. The packaging should only be removed immediately prior to installation.

Lifting tool

Lifting cover for Compact S makes it possible to lift Compact S of the pallet without making any heavy lifts and transport the system around in the home. Detach the filter box and the system fits under an average inner door.



Installation of electric heating element

Electric heating elements (accessories) are fitted in the duct. The fitter should ensure that there is a safe distance of at least 15 cm between the electric heating element and any inflammable material. The heating element must be insulated using fire-resistant insulation material. The electric heating element must be connected by an authorised electrician.

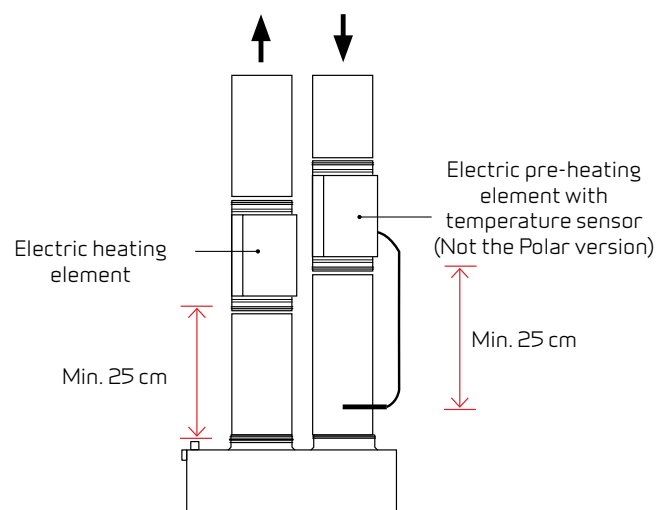

INFORMATION FROM A TO Z

Nilan develops and manufactures premium-quality, energy-saving ventilation and heat pump solutions that provide a healthy indoor climate and low-level energy consumption with the greatest consideration for the environment. In order to facilitate each step in the construction process - from choosing the solution through to planning, installation and maintenance - we have created a series of information material which is available for download at www.nilan.dk.



Brochure

General information about the solution and its benefits.



Product data

Technical information to ensure correct choice of solution.



Installation instructions

Detailed guide for installation and initial adjustment of the solution.



User manual

Detailed guide for regulation of the solution to ensure optimum day-to-day operation.

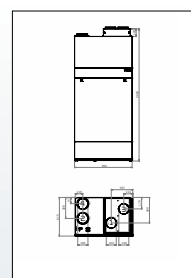

Drawings

Tender documents and 3D drawings are available to download for planning purposes.

WWW.NILAN.DK

Visit us at www.nilan.dk to find out more about our company and solutions, download further information and find your nearest dealer.



Nilan A/S
Nilanvej 2
8722 Hedensted
Danmark
Tlf. +45 76 75 25 00
Fax +45 76 75 25 25
nilan@nilan.dk
www.nilan.dk